

SENKO

INSTRUCTION MANUAL



Central heating
COOKERS

2P-extra rustic and 2P-glass

SN-EN-9/16

For a perfect
warm home!



Dear client, thank you for choosing a SENKO cooker!

This product was designed and manufactured to its minutest details in order to fulfill your every need for functionality and safety.

This *Instruction manual* will teach you to operate your cooker properly, so please read the manual carefully before using the cooker.

Senko management

Symbols used in this *INSTRUCTION MANUAL*:

- ATTENTION 
- WARNING 
- SAFETY 
- ADVICE AND RECOMMENDATIONS 

CONTENTS

1. GENERAL	4
1.1. FUEL	6
1.2. FEEDING	6
1.3. CHIMNEY	7
1.3.1. CHIMNEY CAP	7
1.3.2. CHIMNEY FUNCTION	8
1.4. INSULATION	10
2. WARNINGS AND SAFETY	10
3. TECHNICAL FEATURES	11
4. INSTALLATION	13
4.1. POSITIONING	13
4.2. CHIMNEY PREPARATION AND CONTROL	14
4.3. CONNECTING TO CHIMNEY	15
4.4. FRESH AIR VENTS	19
4.5. OVEN THERMOMETER	21
4.6. CENTRAL HEATING SYSTEM CONNECTION	21
4.6.1. COOKER THERMAL PROTECTION	23
4.6.1.1. Thermal two-way safety valve	24
4.6.1.2. Thermal safety valve	25
4.6.1.3. Anti-freezing protection	26
4.6.2. INSTALLATION TESTING	27
4.6.3. RECEIVING AND MAINTAINING THE INSTALLATION	27
5. HANDLING THE PRODUCT	28
5.1. DIRECTING THE FLUE GAS	28
5.2. AIR ADJUSTMENT AND REGULATION	29
5.3. FIREBOX GRATE	31
5.4. FIRING	32
5.4.1. PROCEDURE	32

5.4.2. OPTIMUM USE VALUES	32
5.4.3. ADDING FUEL	33
5.4.4. FEEDING IN TRANSITION PERIOD	34
5.5. OVEN DOOR	35
6. CLEANING	36
6.1. CLEANING THE FLUE GAS CHANNEL	36
7. MAINTENANCE	37
7.1. AUTOMATIC REGULATOR	37
7.2. FIRING REGIME SWITCH MECHANISM	39
7.3. OLD COOKER DISPOSAL	39
7.4. SPARE PARTS	39
8. MALFUNCTIONS / CAUSES / SOLUTIONS	40
9. TECHNICAL SUPPORT	42
10. TECHNICAL DATA	43
11. TERMS OF WARRANTY	44
WARRANTY	45
INSTALLATION REPORT	46
CE MARKING	47

1. GENERAL

Solid fuel central heating cookers

- ◆ E 2125 L/D C-20 2P extra rustic
- ◆ E 2135 L/D C-30 2P extra rustic
- ◆ E 2220 L/D C-20 2P glass
- ◆ E 2230 L/D C-30 2P glass
- ◆ E 2420 L/D C-20 2P glass design
- ◆ E 2430 L/D C-30 2P glass design

are models from the SENKO cookers palette which can accommodate your needs in the best possible way. Therefore, we ask you to CAREFULLY READ THESE INSTRUCTIONS, which will help you to achieve the best possible results already during the initial use.



The manufacturer is not responsible for any consequences (people or animal injuries or property damages) **resulting from failure to comply with this *Manual***. The cooker is hot during operation and **the use of protective heat insulated gloves is compulsory during handling**. Children and infirm individuals are not allowed to handle the cooker.



The external appearance of the cooker is shown on the first page of this Manual. Cooker principal parts are made of stainless steel boiler plates and castings of quality grey cast. The cookers are produced with flue gas connection point on the left or the right side. **When ordering the cooker or the spare parts, it is necessary to state its full designation**, for example: cooker E 2230 D C-30 2P glass, which means that it is the cooker with glass coating and the flue gas connection is on the right side, if the cooker is observed frontally.



The cookers are manufactured and certified in accordance with the EN 12815 standard and comply with all the requirements set by this standard.

These SENKO cookers are intended for **cooking, baking, space heating and central heating!**

The cooker is packaged in a EURO pallet. During transport, the cooker must be properly fastened in order to prevent tumbling or damages. **The standard delivered cooker set consists from:**

- Cooker,
- Instruction manual,
- Chimney terminal extension (23),
- Firing regime adjustment – grate lifting spanner (24),
- Cooker cleaning tool (25).



Figure 1



CAUTION! The cooker weighs between 450 and 550 kg. Extra caution is necessary when unloading, transferring, moving and installing the cooker in order to avoid physical injury.

1.1. FUEL

The use of moist and low-calorie wood is not recommended. The **wood moisture must be lesser than 17%**. The energy content of moist wood is low, at approx. 2,3 kWh/kg and it greatly pollutes the door glass, as well as the chimney and the cooker.



Use only recommended fuel:



- **wood:** common beech, common hornbeam, oak, black locust
⇒ air dried for a minimum of 2 years
⇒ relative humidity 15-17%, energy content at approx. 4,2 kWh/kg
- **wood briquettes:** energy content at approx. 4,4 kWh/kg

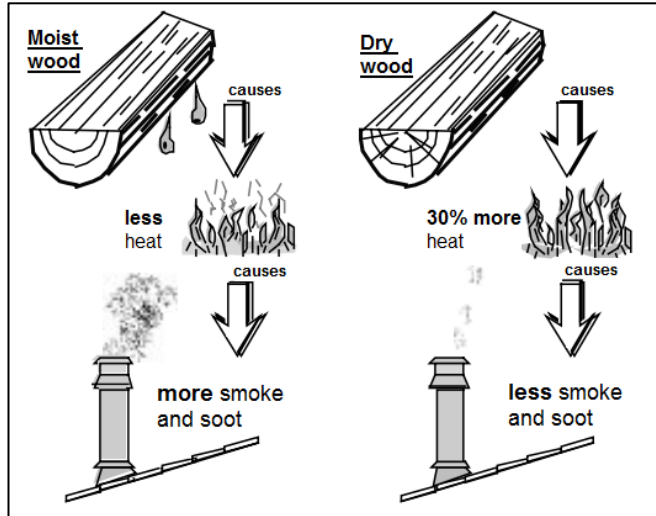

1.2. FEEDING

- manually when necessary
- we recommend the **logs** to be of 50 x 50 mm **vertical cut**, up to 2/3 of the firebox length
- use smaller logs for a more intensive fire, and more massive logs to maintain fire
- **the minimum distance between the logs** must be 1 cm, the same distance of 1 cm applies for the briquettes
- to maintain constant oven temperature, add smaller quantities of fuel occasionally ⇒ approx. 0,5 kg
- it is **necessary to use protective heat insulated gloves** when adding fuel to the firebox
- protective heat insulated gloves must also be used when opening and closing the oven and firebox door and removing the tray from the cooker and ash box.



1.3. CHIMNEY



The cooker is connected to the chimney via **150 mm diameter sliding rosette**. It is necessary to execute the connection of the rosette and the chimney tightly and impermeably. **If the cooker is separated from the chimney opening (not recommended)** the connection is made via **standard 150 mm diameter smoke venting pipe** – see *chapter 4.3*.



We also advise to equip the chimney with **solid material and possible condensation products collection chamber** and to install the chamber in question beneath the smoke channel inlet, in a manner which allows easy access and inspection via impermeable door.



IMPORTANT

- **BEFORE** connecting to the chimney it is necessary always to make a calculation (according to EN 13384 and all other standards for the chimney dimensioning)!
- The chimney has a very important function of the smoke exhaust at solid fuel heating devices and therefore **MUST BE well and properly dimensioned!**



1.3.1. CHIMNEY CAP

Chimney cap must fulfill the following prerequisites:



- **identical internal diameter** to that of the chimney,
- operational **exit cross-section no less than the double inner diameter of the chimney** – see $B \geq 2 \times A$ in the Figure beside,
- constructed to **prevent rain, snow, leaves and other foreign bodies from entering** the chimney,
- constructed to **enable expulsion of combustion products in case of wind** from any direction and incline,
- installed to **enable proper dispersion and dilution of combustion products outside the reflux zone** (backflow) because the counter pressure occurs here. Therefore, it is necessary to adhere to limitations listed in *Figure 2*,
- **mechanical appliances for flue gases suction are not allowed.**

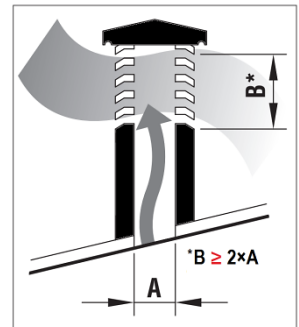

FLAT ROOF

PITCHED ROOF

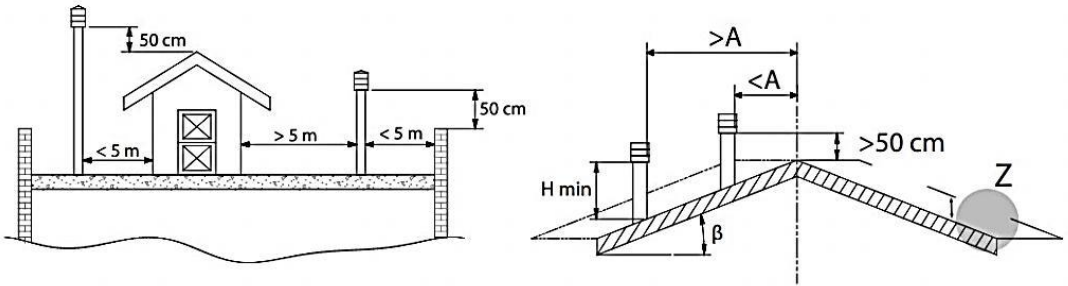

Figure 2

Z=REFLUX ZONE

Roof slope	Distance between the roof ridge and the chimney	Minimum chimney height (measured from the roof surface)
β	A, m	H_{min} , m
15°	< 1,85	0,5 m above the roof ridge
	> 1,85	1 m from the roof
30°	< 1,5	0,5 m above the roof ridge
	> 1,5	1,3 m from the roof
45°	< 1,3	0,5 m above the roof ridge
	> 1,3	2 m from the roof
60°	< 1,2	0,5 m above the roof ridge
	> 1,2	2,6 m from the roof

1.3.2. CHIMNEY FUNCTION

Among all the meteorological and geographical factors that influence the chimney function (rain, fog, snow, insolation period, etc.) **the wind is most certainly the crucial one.** Apart from the pressure caused by the temperature difference between the flue gases and the outer chimney air, there is another type of pressure – **wind dynamic pressure.**



Ascending wind ALWAYS has the effect of increasing the pressure, i.e., underpressure (flue draught), provided the chimney is properly installed. Descending wind ALWAYS has the effect of decreasing the draught \Rightarrow overpressure occurs. Apart from wind direction and velocity, chimney position in relation to the house roof and surrounding area is also important (Figure 3).

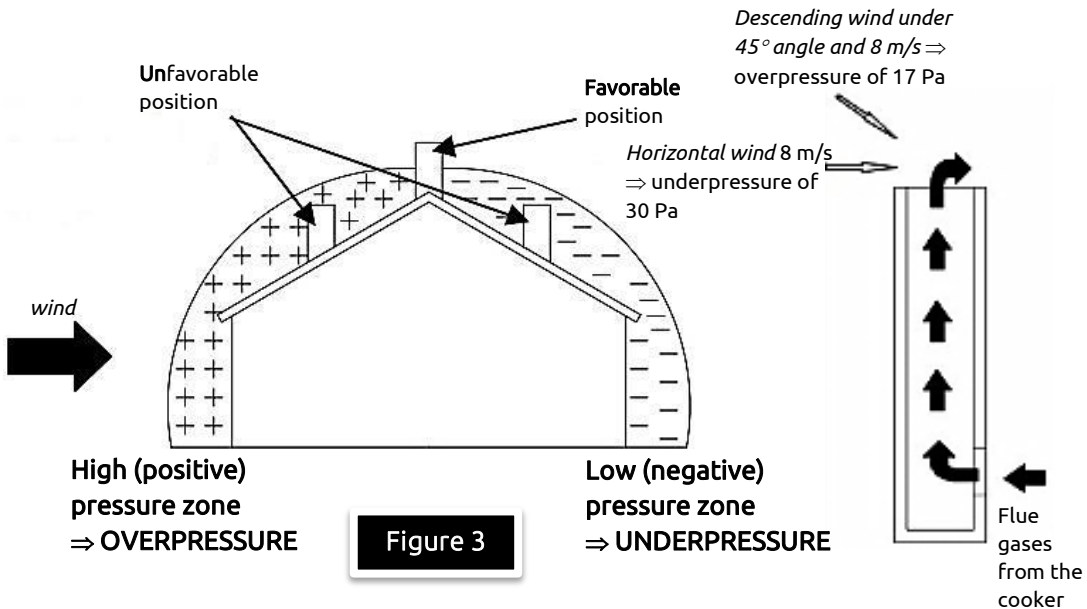

The wind also influences the chimney function indirectly by creating areas of high (overpressure) and low (underpressure) pressure, both inside and outside the residential area (Figure 4).

Pressure that facilitates chimney function can occur in rooms directly exposed to the wind (B), but it can also adversely affect the chimney through external pressure if the chimney is situated on the side exposed to wind (A). Contrary to that, underpressure can occur in lee rooms (C), adversely affecting functions of the chimney situated on the opposite side (D) from the wind direction.

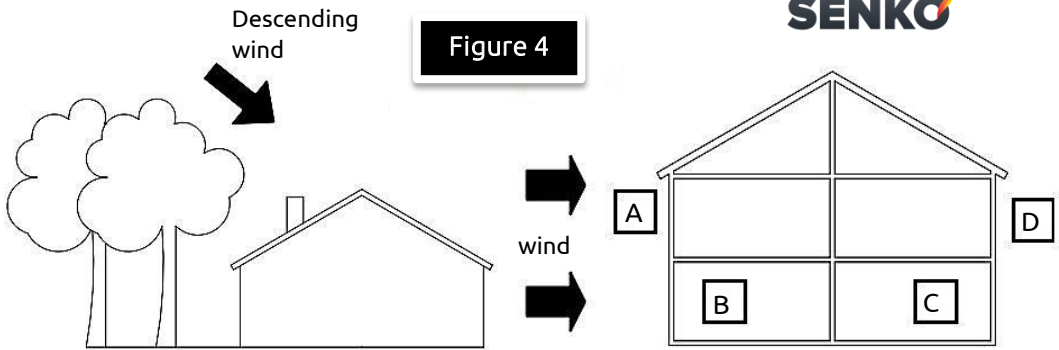

Figure 4

A-B zones in overpressure
C-D zones in underpressure

1.4. INSULATION

The cooker is insulated in the boiler area towards the external surfaces with fire resistant rock wool, 20 mm thick. Other internal cooker parts are insulated with chamotte brick, 25 mm thick. Chamotte brick, 60x60 mm is used around the upper frame.

2. WARNINGS AND SAFETY

When connecting the cooker to the chimney and the central heating system, **adhere to national and European norms and local regulations**. Prior to use, verify with the local authorized chimney-sweeper whether **the cooker is properly connected to the chimney** (the chimney-sweeper must complete the installation report at the end of this *Manual*).



PROCEDURE IN CASE OF CHIMNEY FIRE

*In case of chimney fire, close the openings for the air inlet and **DON'T open the firebox door**. Extinguish the fire using appropriate fire extinguishers. **NEVER EXTINGUISH A FIRE WITH WATER!** In case of fire also call the local fire department. Comply with local regulations for fire protection!*



Special attention must be paid that there is enough air for combustion being supplied to the room cooker is installed in.

Prior to commencing the firing procedure, the cooker **MUST be connected to waterworks and central heating installation**. The procedure may only be executed by **an authorized expert** who completes the installation report at the end of this *Manual*.



3. TECHNICAL FEATURES

SENKO cookers 2P extra rustic and glass are intended for cooking, baking, sanitary water heating and household heating. They are constructed on the model of old brick kitchen cookers which had large ovens. The cookers are made of **stainless and steel plates and castings of quality grey casts**. The boiler is made of highly resistant quality boiler sheet according to EN 12815. The cooking plate (1) is made of 8 mm thick steel plate. Cooker interior is lined with chamotte. Exterior plates can consist of ceramic tiles or tempered glass in different colours (according to the customer wishes).

The ash box (14) is on the frontal side, at the bottom; above is the secondary air regulator (11) (behind the protective cover) and the firebox (8). Connections for the central heating system are on the rear side of the cooker.

Cooker **firebox** (8) can function as both **summer and winter** firebox, depending on the position of the firebox lower grate.

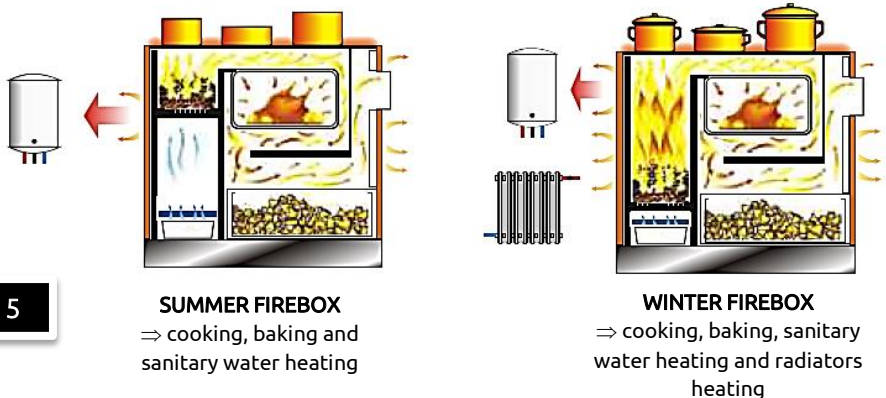

Figure 5

The following figures display the schematics of the cooker and their accompanying parts.

SCHEMATIC DISPLAY FOR 2PCOOKER

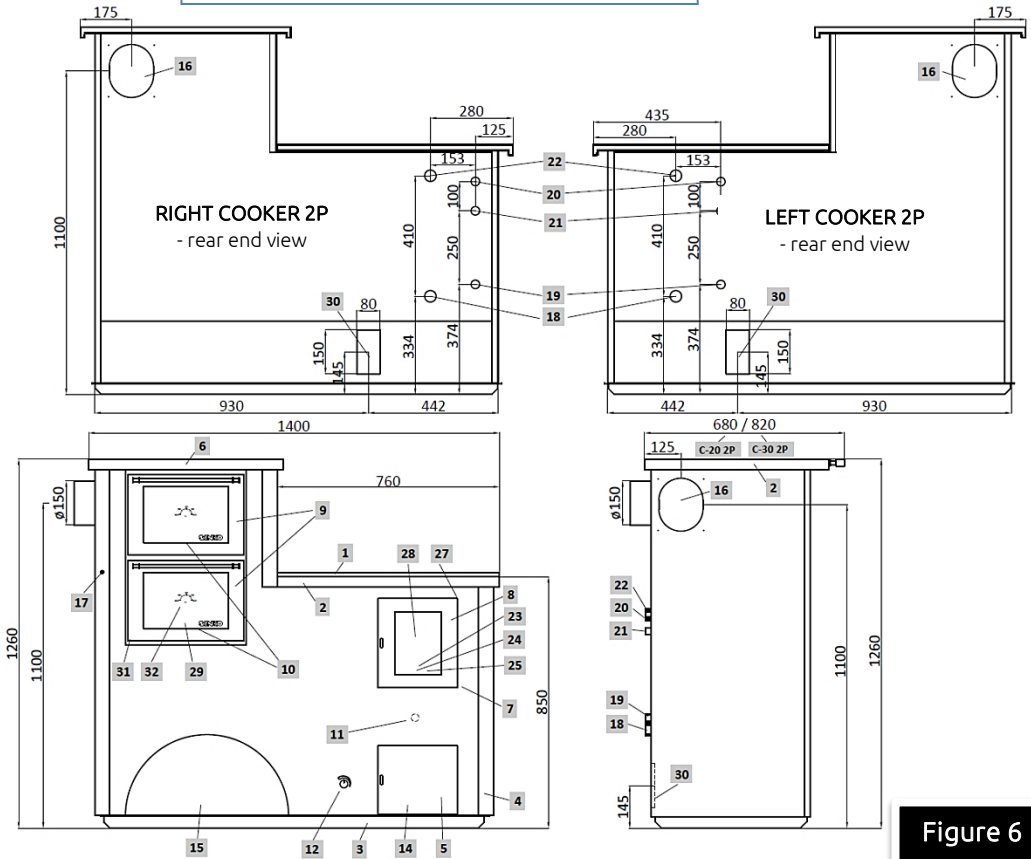

Figure 6

THE KEY:

- | | | |
|-------------------------------------|--|--|
| 1. Cooking plate | 16. Chimney connection point | 23. Chimney connection point extension |
| 2. Frame | 17. Flue gas deflector | 24. Firing regime adjustment spanner |
| 3. Cooker base | 18. R1" cold water connection point of the boiler thermal protection | 25. Cooker cleaning tool |
| 4. Cooker housing | 19. R1/2" inlet water connection point of the boiler thermal protection | 27. Door hinge bolt |
| 5. Lower door | 20. R3/4" two-way safety valve connection point of the boiler thermal protection (see page 24), i.e. boiler thermal protection safety valve probe (see pgs. 25 and 26) | 28. Firebox door glass |
| 6. Top plate | 21. R1/2" outlet water connection point of the boiler thermal protection | 29. Oven door glass |
| 7. Boiler with base | 22. R1" warm water connection point | 30. Primary air inlet hatch |
| 8. Firebox door | | 31. Oven door hinge |
| 9. Oven with door | | 32. Oven thermometer |
| 10. Cleaning hatch lid | | |
| 11. Secondary air regulator | | |
| 12. Primary air automatic regulator | | |
| 14. Ash box | | |
| 15. Fuel box | | |

4. INSTALLATION



Once you have removed packaging from the cooker, it is necessary to **make a detailed inspection in order to determine any potential damages** that might have occurred during transport. Any detected damages must instantly be reported to the manufacturer.

In places of any connection points on the cooker (water, thermal protection, chimney, air inlet), **inspection hatches must be installed for system maintenance and servicing purposes.**

4.1. POSITIONING



A spirit level must be used to place the cooker in a horizontal position with no incline. It is necessary to ensure **the minimum distance of the cooker from any flammable objects**; such as wood, chipboard, cork and similar. If the materials are easily combustible such as PVC, polyurethane and similar, the necessary safety distances need to be doubled.

The minimum distance from any flammable surfaces above is 1000 mm and in front of the cooker is 800 mm, and 200 mm in all other directions.



When mounting the cooker on the floor made from easily combustible material (**wooden floors**), the cooker must be **mounted on an insulating non-combustible surface.**

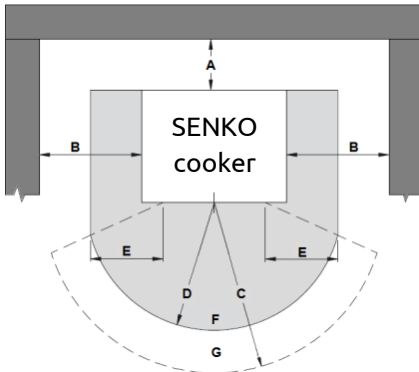

A	200 mm from the rear wall
B	200 mm from the side wall
C	800 mm from the front side
D	500 mm floor protection
E	300 mm (measured from the maximum angle of firebox door opening)
F	Floor protection
G	Radiation area

A cooker should not be placed in rooms where there are gas stoves or cookers, and in the bathroom, in buildings intended as laundries or similar. The same applies for rooms or flats with air circulation or hot air circulation with ventilation systems (air condition, extractor or kitchen hoods), **EXCEPT** if such ventilation systems have safety mechanisms, which sustain the air pressure above 4 Pa in a room, where the cooker is mounted or in rooms which are in direct contact with exterior air.



It is recommended to place the cooker as close as possible to the chimney hole, i.e. next to the chimney hole itself in order to avoid using an additional smoke uptake pipe (*Figure 7a*).



4.2. CHIMNEY PREPARATION AND CONTROL

Prior to cooker mounting, it is necessary to check the chimney – the diameter, height, possible clogging or damages. The chimney must be certified by an authorized local chimney-sweeper. The effective chimney height must be **at least 5 meters** from the point of flue gases outlet (*Figure 7b*).



Flue draught must be within parameters:

- for C-20 2P $\Rightarrow 12 \pm 2$ Pa,
- for C-30 2P $\Rightarrow 15 \pm 2$ Pa.

The chimney must be **at least 0,5 meters above the roof ridge** (see *Figure 2*).



The minimum distance between the two connections on the same chimney must be **60 cm** (*Figure 7d*).

Chimney diameter is chosen according to information provided by the chimney manufacturer – e.g., for flue draught of 15 Pa, the diameter is usually 160 mm.

The chimney must be smooth on the inside, well insulated and well fastened. All cleaning hatches must be well fastened. All gaskets must be regularly inspected and replaced when necessary.

4.3. CONNECTING TO CHIMNEY

When connecting the cooker to the chimney it is necessary to adhere to local, national and European regulations (norms) – **DIN 4705**.

It is necessary to ensure that **the connection between the cooker and the chimney is executed tightly and impermeably.** Smoke outlet pipe must have a suitable incline (minimum 3°) in cases where the cooker is removed from the chimney opening.



Smoke outlet pipe must not penetrate into the chimney clear opening (*Figure 7c*).



Connect the cooker to the chimney **using a sliding rosette, 150 mm in diameter.** Specially designed sliding rosette enables the adjustment of the chimney opening in tolerance of 1,5 cm upwards, i.e. downwards.

In case it is necessary to keep the cooker removed from the chimney opening, use the standard smoke outlet pipe, 150 mm in diameter.



It is not allowed to reduce the prescribed pipe diameters!

a)

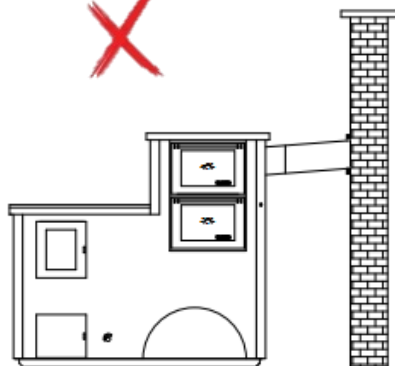
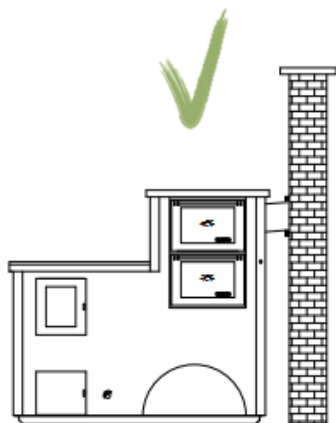

b)

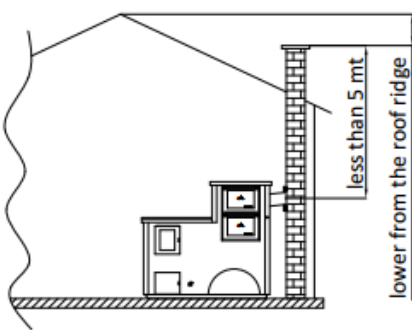
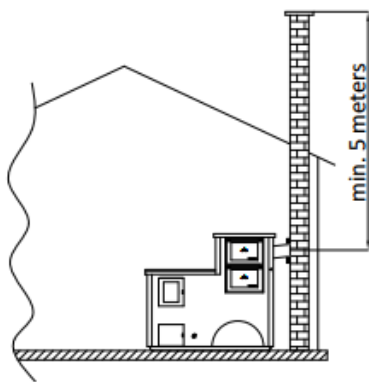

c)

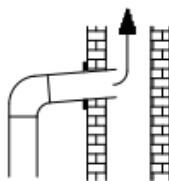
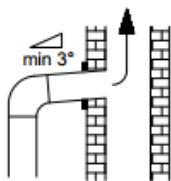

d)

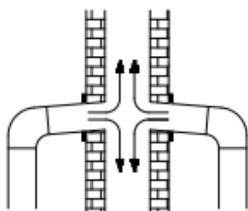
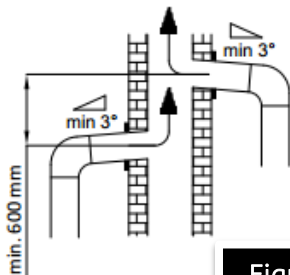

Figure 7

Differences between the proper and improper connection of the cooker to the chimney

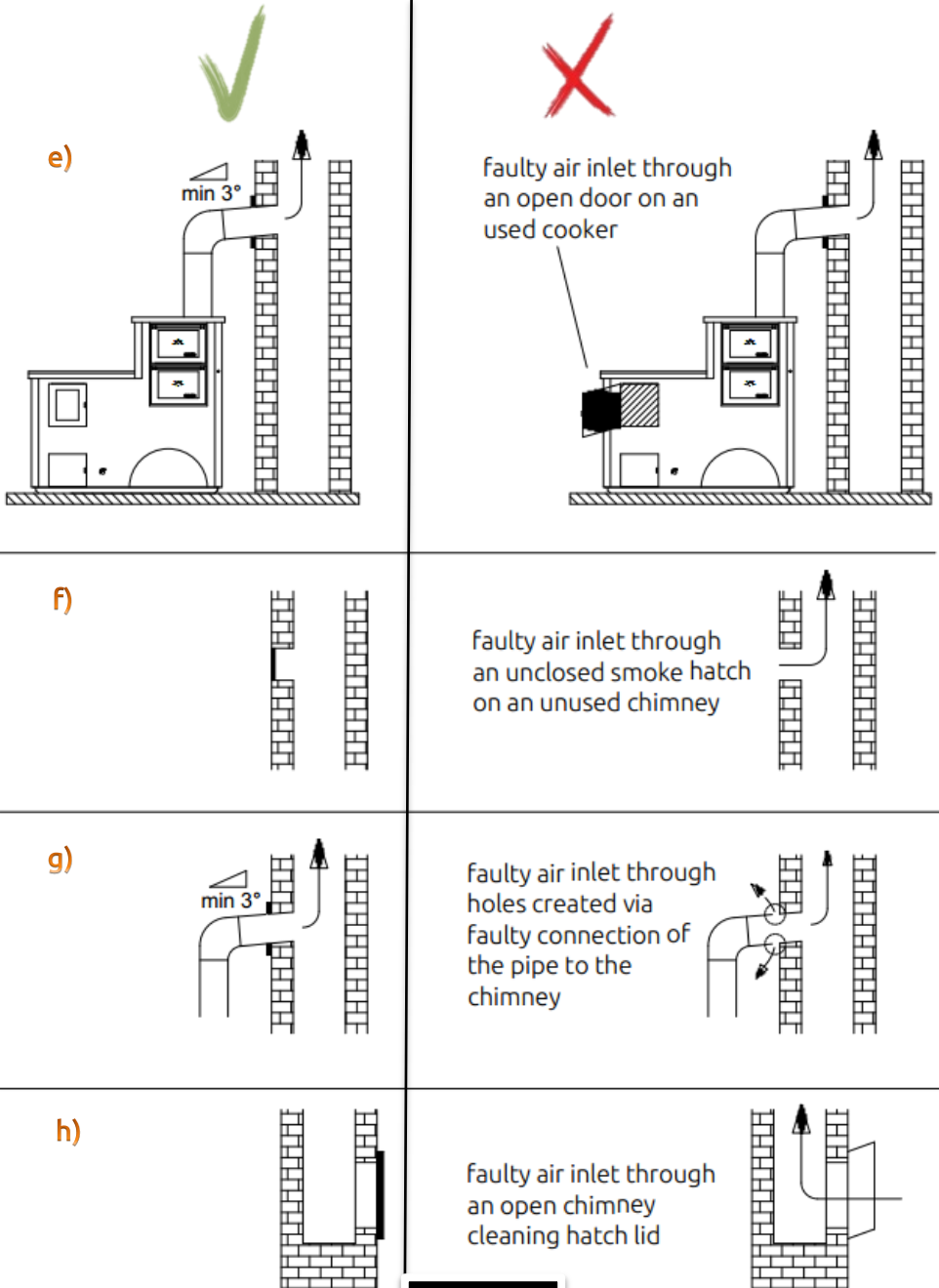
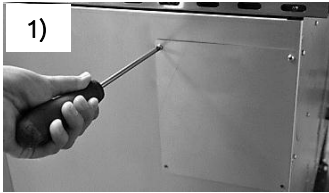

Figure 7

In case it is necessary to connect the cooker to the chimney **with vertical uninsulated pipe**, use the smoke outlet pipe, **up to 125 cm maximum length**.

If the cooker is further removed from the chimney opening, it is connected via extension tube and an elbow. The extension smoke inlet pipe must have an appropriate incline (see Figure 7) and must not exceed 100 cm in length. The connection of the chimney and the smoke inlet pipe must be completely fastened!



1) Remove the external protective lid with a screwdriver



2) Remove the sheet beneath the lid by pressing onto the weakest juncture



3) Mount the protective lid onto the remaining chimney opening! 



4) Remove the internal protective lid with a screwdriver



5) Install the sliding rosette by using bolts previously used to attach the inner protective lid

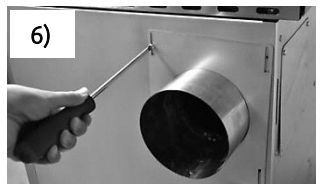

6) Install the external protective sheet by using bolts previously used to attach the external protective lid

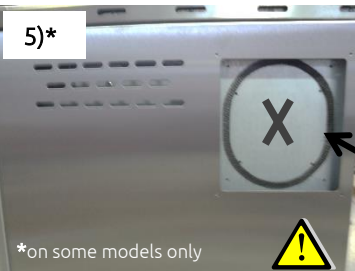

5)*

*on some models only

Before installing the sliding rosette, it is **obligatory to stick the self-adhesive strip** (provided with your cooker) on the inner sheet metal!

When installing the sliding rosette **on the back of the cooker** it is necessary to:

- remove the external protective lid with a screwdriver,
 - by gently pressing remove the following lid,
 - in place of the external lid attach the sliding rosette with the same screws.
- In doing so, you have remain the external sheet metal of the rosette and external lid (which are at the beginning removed from the cooker), as excess. 

Figure 8

4.4. FRESH AIR VENTS

The room where the cooker is installed **must be provided with sufficient air inflow to ensure combustion**. The area must be regularly ventilated.



The fresh air vent must be situated **near the room floor** and allow the inflow of fresh air into the room. **The minimum dimension of the vent must be 6 cm² per kW of nominal power** (e.g. for 30 kW ⇒ 180 cm² ⇒ 10 x 18 cm vent).

A pipe can also be installed on the existing opening 150x80mm or Ø120mm (depending on the cooker model) on the rear side of the cooker, for the purpose of entering fresh outside air – see also *Figure 15*.

ORIENTEERING and SIMPLIFIED schemes of connecting to the combustion air supply

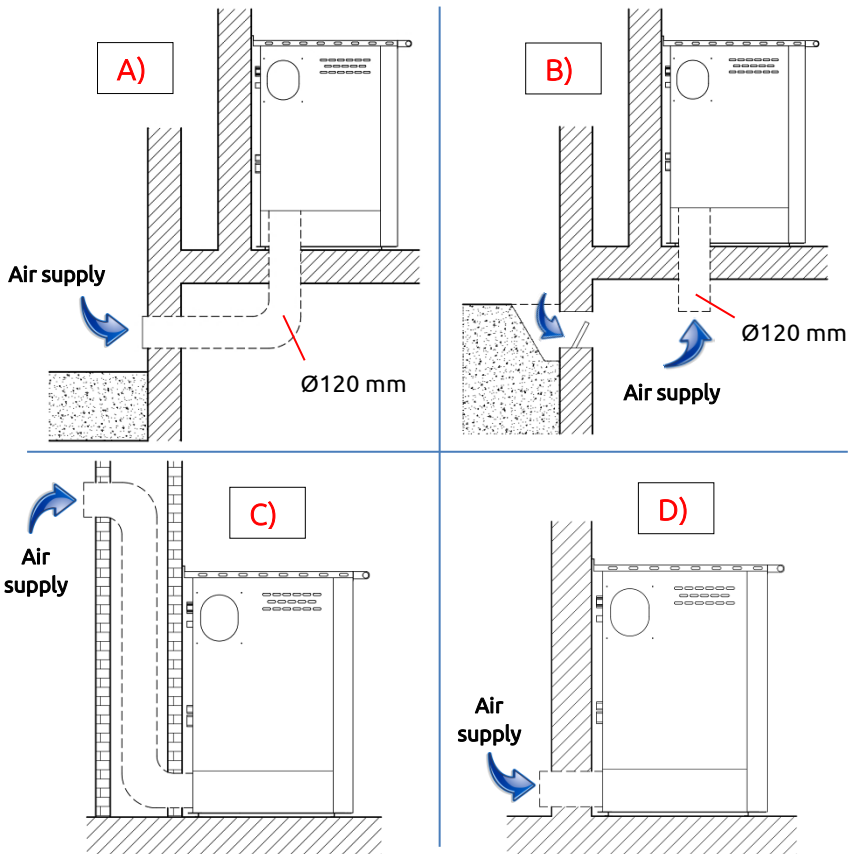

A) *Combustion air supply via pipe line through a basement room*

The combustion air is preheated with this connection option, which is favorable to a clean combustion. The routing in the basement room is easy to make.



B) *Combustion air supply via a basement room*

The combustion air is preheated. The basement room must be excluded from the home ventilation system and be open to the outside. High levels of dust and moisture should be avoided.



C) *Combustion air supply from above*

An air supply from above may only be performed with tested chimney systems. A chimney calculation is mandatory here!



D) *Combustion air supply directly from outdoor*

With an air supply directly through the outside wall, the combustion air is only slightly preheated, which is unfavorable to a clean combustion. There is also the danger of condensation!



NOTE: This version of the air supply is not recommended!



Please be aware!

- A prerequisite for the connection of cooker used in combination with domestic ventilation systems is that the approval of the local qualified chimney sweep is obtained!
- It is not permitted to install cut-off devices in the supply air duct (dampers, sliders, etc.). To prevent air from permanently flowing through the appliance when it is not in use, close the dampers in the appliance.
- Make sure that the outdoor air inlet is protected against blockage by means of a protective grating.
- For the supply air duct to the combustion air connecting piece it is best to use a non-combustible, flexible aluminium hose. Max. length 4 m with 3 bends.
- The supply air duct must be insulated to avoid condensation and must be protected against wind!
- According to the regulations for chimney sweeping and inspection ventilation systems must be checked for blockages once a year by the local qualified chimney sweep. To facilitate this, appropriate inspection doors should be provided. Please consult your local qualified chimney sweep regarding this matter.

4.5. OVEN THERMOMETER



Thermometer (32) indicates the oven temperature; this value is informative. **If the oven temperature exceed 300 °C, the oven must be partly opened to prevent damage to the thermometer, oven door hinge and oven door.**

The warranty will be void in case the damage to the parts listed before occurred from excessive oven temperature.

4.6. CENTRAL HEATING SYSTEM CONNECTION

Prior to commencing the firing procedure, the cooker must be connected to waterworks and central heating system and the boiler must be filled with water. **Continuous circulation of water through the boiler** must be ensured. The boiler must be well deaerated prior to operations commencement.



The pipe installation **must be executed in accordance with valid technical regulations** and DIN 4751 norm – part 1 for open systems and DIN 4751 – part 2 for closed systems, following **professional standards**, and **only by an authorized expert**.



It is not allowed to reduce the diameter of the pipe connecting the boiler to the heating installation connection point. Otherwise, the warranty will be void.



Prior to connecting the boiler to the heating installation, **the pipelines are to be thoroughly cleansed from potential filth sediments**. This prevents boiler overheating, system noise, pump malfunctions and mixing valve malfunctions. **The connection** to the heating system **is executed via union flat joint, with or without the mixing valve** onto an open or closed system.



Installation of an approved safety valve with opening overpressure set to 3 bar is mandatory in closed systems.

Safety and expansion conduits must not have any kind of block elements.

ORIENTEERING and SIMPLIFIED scheme of connecting to an *open* central heating system

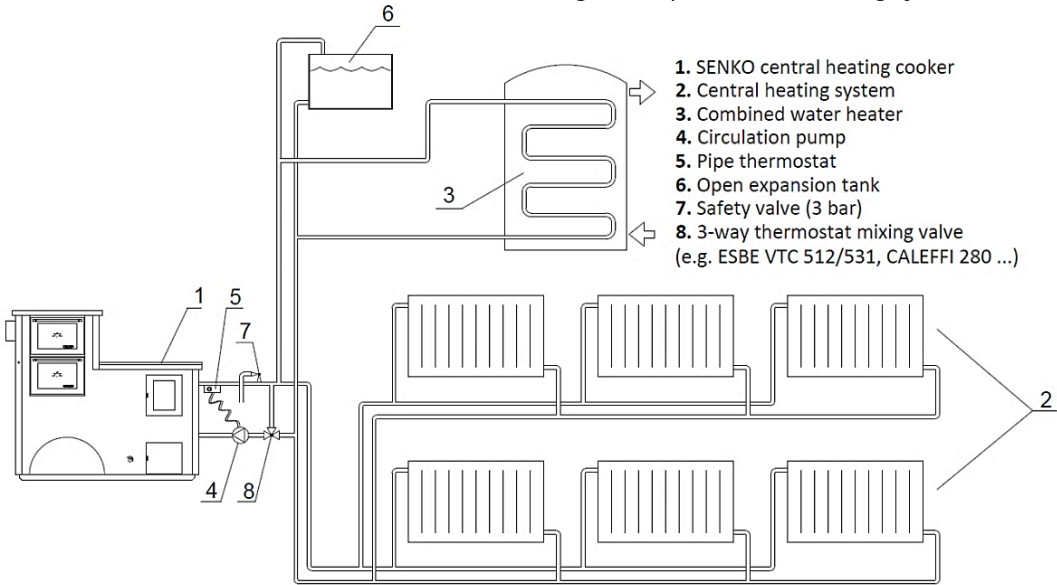
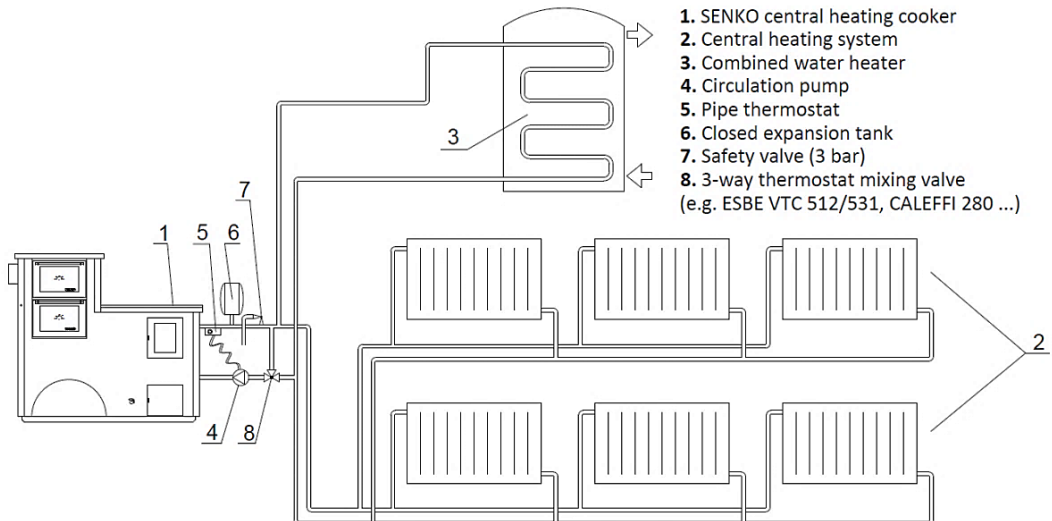

Figure 9

ORIENTEERING and SIMPLIFIED scheme of connecting to a *closed* central heating system



It is necessary to **install the deaerating valve**. When filling the boiler and the radiator system it is necessary to open the mixing valve, if one had been installed; adequately deaerate the boiler and the heating system.



The **mixing valve** (8–Figure9) maintains the boiler temperature at **minimum 55°C**, thus preventing the boiler from condensation. If one had not been installed, it is necessary to ensure firing conditions that will prevent boiler condensation ⇒ **pipeline thermostat** (5–Figure9) **which activates the circulation pump must not be adjusted to values lower than 55°C!** Condensation may appear at the beginning of the firing process or due to insufficient feeding.



4.6.1. COOKER THERMAL PROTECTION



When connecting the cooker to the central heating system it is **necessary to install the safety thermal valve**. It shall be installed on the **cooker rear side to R3/4" connection point** – inner thread⇒*Figures 10-12*.

Water outlet into the sewer (or SW tank – sanitary water) is connected to connection point:



- **R3/4" (7)** - *Figure 10*, OR
- **R1/2" (7)** - *Figure 11*, OR
- **R3/4" (8)** - *Figure 12*.

The **sensor (probe) of the safety thermal valve** is connected to the **connection point (5)** ⇒ broken line in *Figures 10-12*.

The central heating system must have its own separate **thermo-manometer!**



THE BOILER MUST NOT BE USED WHEN EMPTY OF WATER!

Orientational schematic for cooker connecting to a central heating system with a thermal two-way safety valve



4.6.1.1. THERMAL TWO-WAY SAFETY VALVE

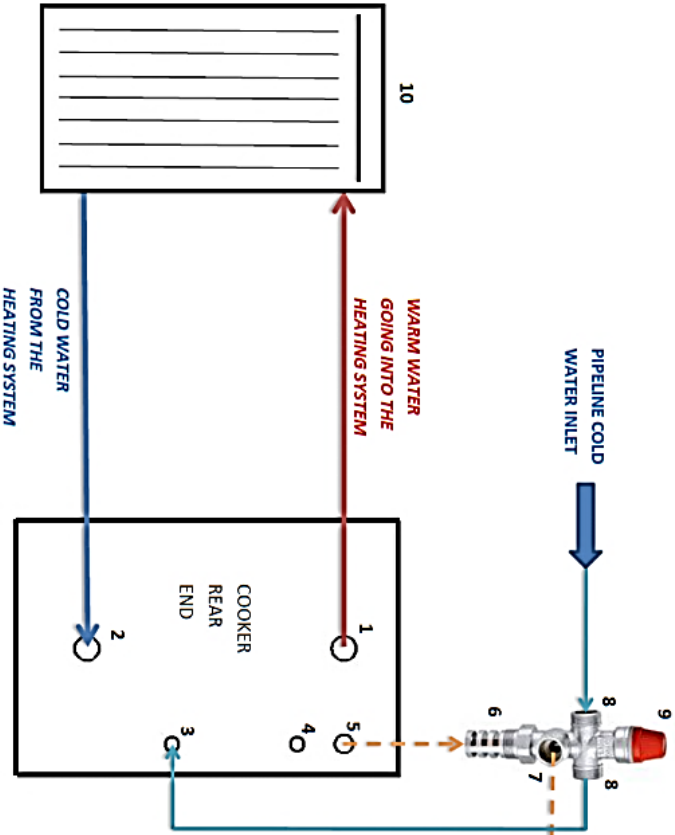

THE KEY:

- 1 – R1" warm water connection point
- 2 – R1" cold water connection point
- 3 – R1/2" inlet water connection point of the boiler thermal protection
- 4 – R1/2" connection point CLOSE!
- 5 – R3/4" safety valve connection point of the boiler thermal protection
- 6 – R3/4" safety valve thermostatic element connection point
- 7 – R3/4" outlet warm water connection point
- 8 – R3/4" inlet cold water connection point
- 9 – thermal two-way safety valve
 - CALFEFI 544501, REGULUS DBV1, HERMAN TDS1...
 - ⇒ valve maximum operational pressure: 6 bar
 - ⇒ maximum temperature valve can withstand: 120°C
 - ⇒ maximum water flow with 1 bar pressure difference: 1,8 m³/h at 110°C
- 10 – heating system

NOTE: Execute the installation in accordance with valid technical regulations and the DIN 4751 norm – part 1 for OPEN SYSTEMS and DIN 4751 – part 2 for CLOSED SYSTEMS, following all professional rules, and only by an authorized expert.

Figure 10

4.6.1.2. THERMAL SAFETY VALVE

Orientational schematic for connecting the cooker to the central heating system with CALEFFI 544400 thermal safety valve

NOTE: Execute the installation in accordance with valid technical regulations and the DIN 4751 norm – part 1 for OPEN SYSTEMS and DIN 4751 – part 2 for CLOSED SYSTEMS, following all professional rules, and only by an authorized expert.

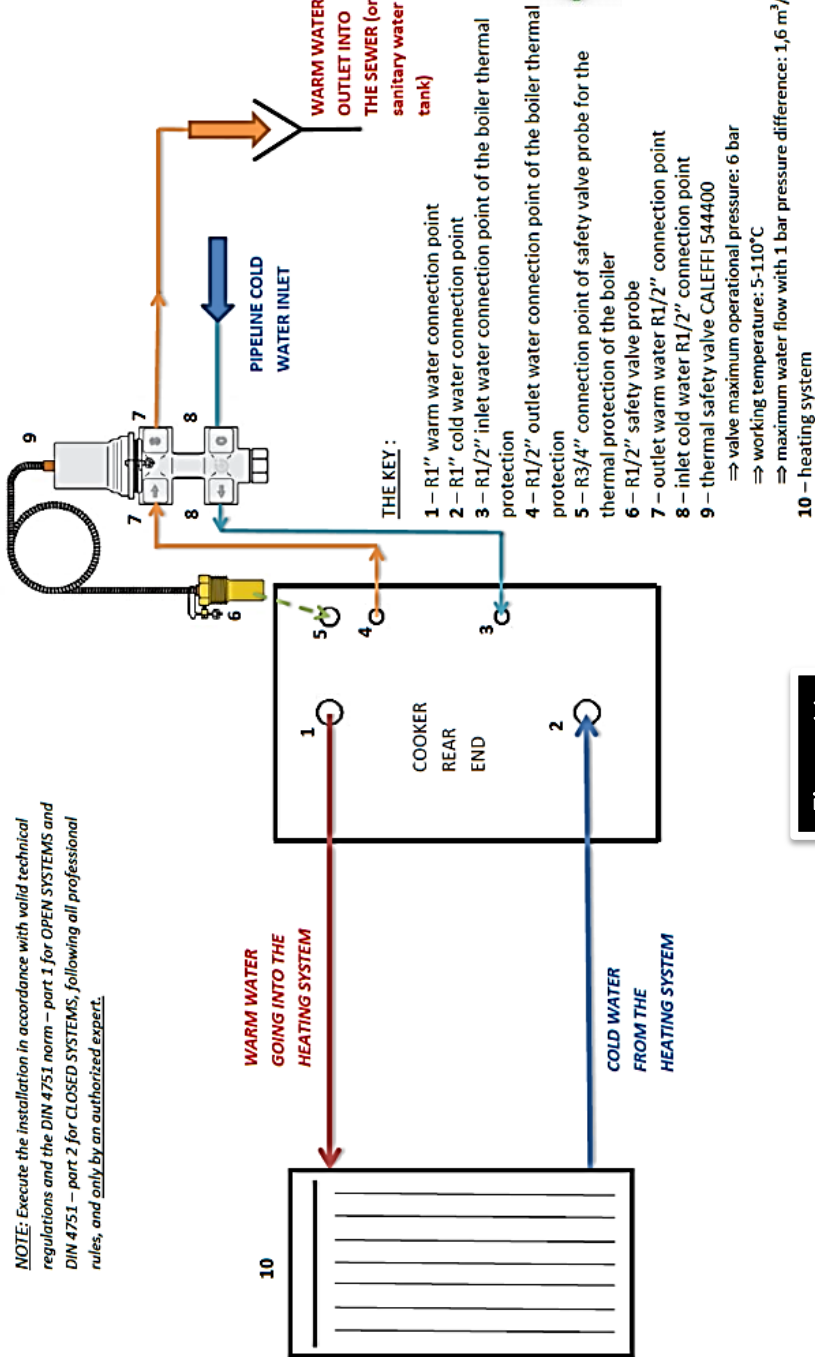

Figure 11



4.6.1.3. ANTI-FREEZING PROTECTION

THE KEY :

- 1 – R1” warm water connection point
- 2 – R1” cold water connection point
- 3 – R1/2” inlet water connection point of the boiler thermal protection
- 4 – R1/2” outlet water connection point of the boiler thermal protection
- 5 – R3/4” connection point of safety valve probe for the thermal protection of the boiler
- 6 – inlet warm water R2” connection point of the safety heat exchanger
- 7 – outlet cold water R2” connection point of the safety heat exchanger
- 8 – R3/4” inlet/outlet water connection point
- 9 – R1/2” connection point CLOSEI
- 10 – R3/8” connection for the deaerating valve
- 11 – safety (cooling) heat exchanger
 - such as BUDERUS Logano GZ11 coolant loop, BOSCH safety exchanger, VIADRUS cooling exchanger...
- 12 – heating system
- 13 – thermal safety valve CALEFFI 544400

Orientational schematic for connecting the cooker to the central heating system with anti-freezing protection (antifreeze)

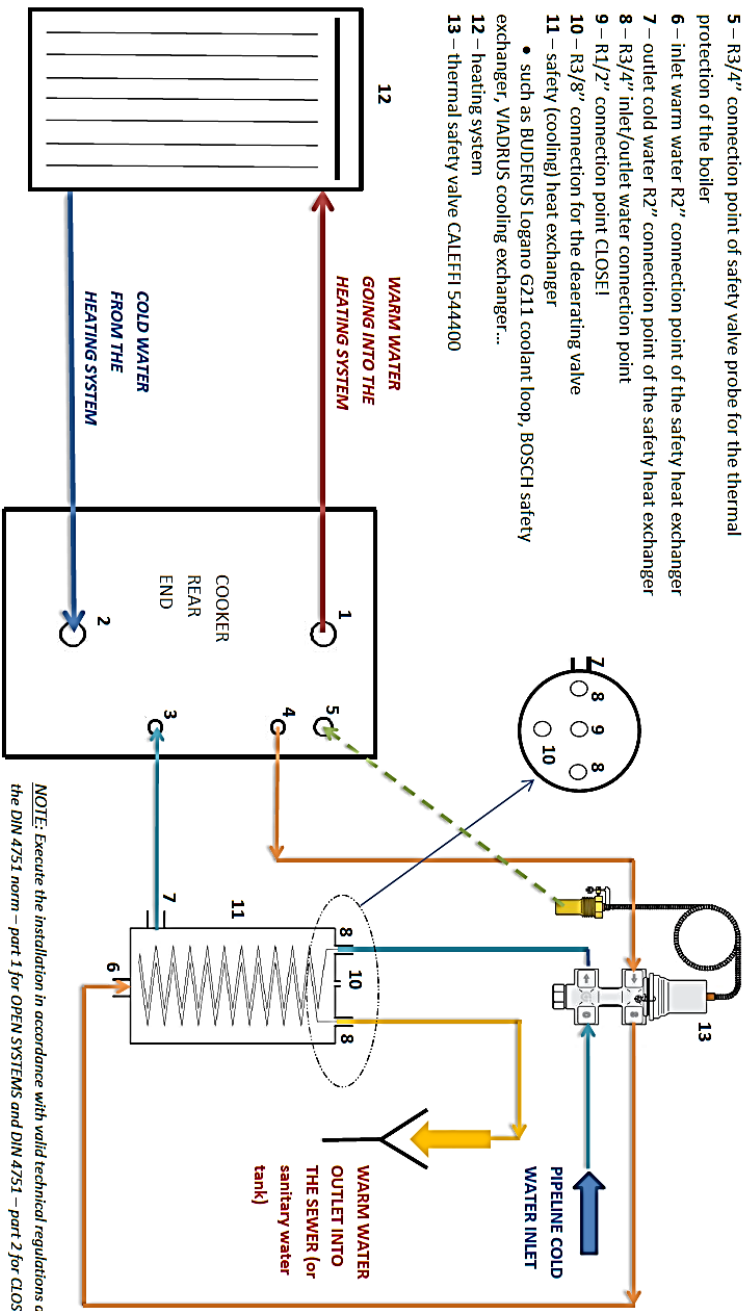

NOTE: Execute the installation in accordance with valid technical regulations and the DIN 4751 norm – part 1 for OPEN SYSTEMS and DIN 4751 – part 2 for CLOSED SYSTEMS, following all professional rules, and only by an authorized expert.

Figure 12

4.6.2. INSTALLATION TESTING



Prior to initial firing it is necessary to check if the boiler and the entire heating system are filled with water and well deaerated. Also check if the smoke uptake pipe is properly fastened.

After initiation make sure:

- there is no leakage of any kind,
- that the entire installation is deaerated,
- that the water temperature in the boiler is increasing,
- that boiler operations do not result in condensation (“sweating”) in the chimney.



Repeat the entire inspection after several days of constant feeding!



Also, **PRIOR TO INSTALLATION activate the safety valve and check its proper functionality.**

4.6.3. RECEIVING AND MAINTAINING THE INSTALLATION

When receiving the installation, inspect the installation in its entirety with the contractor. **The contractor is obligated to provide basic information about the installation operations and indicate the position and function of the installation key components.** Also, the contractor is obligated to complete the installation report which can be found at the end of this *Manual!*



Deaerate the entire heating system after several days and refill it with water if necessary.



Inspection of installation working performance is to be executed at least once a year by an authorized maintenance technician. This will ensure safe working performance of the boiler, as well as economic and immaculate heating.



In case of installation faulty operation, contact your central heating installation contractor exclusively!

5. HANDLING THE PRODUCT

⇒ holding the cooker frame is **not allowed** while handling the appliance !



5.1. DIRECTING THE FLUE GAS

Flue gas deflector (17) accelerates the expulsion of flue gas from the cooker when this is necessary. It is primarily **used during initial stages of firing or when larger quantities of fuel are added** into the firebox.

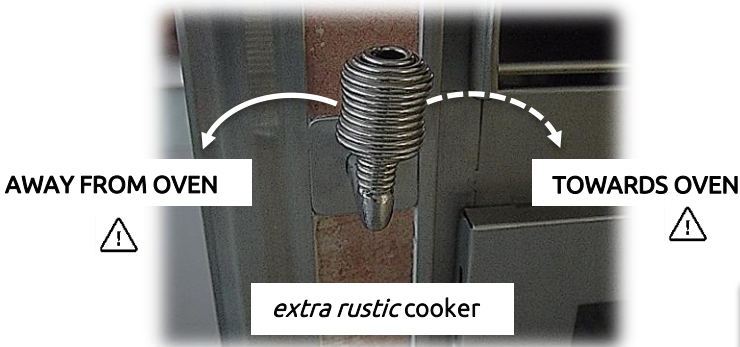

Figure 13

opened flue gas deflector (17)
⇒ flue gases coming out directly into the chimney

OR

closed flue gas deflector (17)
⇒ flue gases orbiting the upper and lower oven



Using the flue gas deflector (17) can be regulated also an oven temperature (9) ⇒ **if the flue gas deflector is open, the oven cools.**



5.2. AIR ADJUSTMENT AND REGULATION

CHIMNEY

If the chimney is equipped with a vent damper, it must be adjusted to keep the **chimney flue draught within the limitations:**



- for C-20 2P $\Rightarrow 12 \pm 2$ Pa,
- for C-30 2P $\Rightarrow 15 \pm 2$ Pa.

PRIMARY AIR

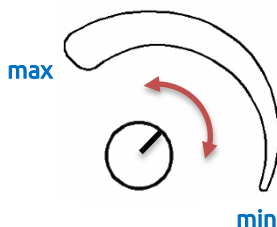

Figure 14

Primary air is the air that flows directly through the firebox grate. There is an **automatic primary air regulator (12)** between the fuel box (15) and ash box (14). Its probe, which measures the temperature of the water in the boiler, is placed on the boiler frontal side under the lid, between upper and lower door.



Turning the PVC wheel of the automatic regulator **regulates primary air flow**. Regulator is set in accordance with the desired boiler water temperature. The division ranges **from min** (thin end of the semicircle) **to max** (wide end of the semicircle):

- min \Rightarrow automatic regulator is closed and there is no primary air flow,
- max \Rightarrow primary air opening is completely open and the flow is at its maximum.



There is a rectangular **150x80mm** or round **Ø120mm** (depending on the cooker model) **connection point for the intake of external primary air** on the cooker rear side, onto which a pipe can be connected – see *Chapter 4.4.* and *Figure 15.*

If necessary, the rectangular cross-section may be reduced and turned into a round opening (minimum diameter 120 mm). The connecting pipe or the reduction must be made out of non-flammable material (in accordance with DIN 4102-B1).

Figure 15

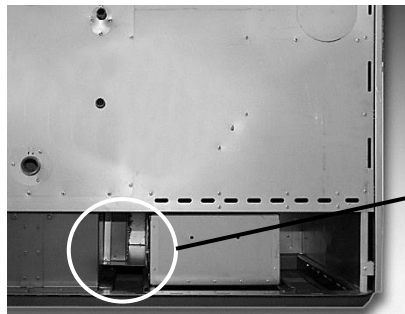

primary air connection point (30) on the cooker rear end

SECONDARY AIR

Secondary air is the air that flows into the firebox to facilitate maximum combustion, reducing harmful substances to ashes and discharging flue gas with low capacity for pollution into the chimney.

Secondary air regulator (11) is placed on the cooker front side under the lid, between upper and lower door.

5.3. FIREBOX GRATE



Cooker firing regimes differ during summer and winter (**winter and summer regime**) – *Figure 5*. The regimes are determined by the position of the lower firebox grate.

The grate is positioned via special mechanism:

- summer regime – the grate is elevated as necessary,
- winter regime – the grate is lowered.



Grate adjusting mechanism is placed in the lower door opening (5). Firing regime adjustment spanner (24) is used to elevate the grate.

Once the grate has been placed in the desired position, the spanner must be removed from the mechanism; otherwise the lower door (5) cannot be closed.

Figure 16



firing regime
adjusting
mechanism with
regime adjustment
spanner (24)



- wide grate openings must be positioned facing downwards at all times to allow the ashes to fall down!
- grate lifting and lowering is executed **ONLY** when the cooker is cold!

5.4. FIRING

5.4.1. PROCEDURE

Prior to every firing, follow the following procedure:

- if the chimney is equipped with a vent damper, open it completely,
- open the flue gas deflector (17) and set the automatic primary air regulator (12) to maximum,
- open the firebox door (8) (maximum door opening angle is 90°),
- put the kindle wood into the firebox and ignite it,
- close the firebox door (8),
- monitor flame progression through the firebox door,
- once the fire is in full flame, add wooden logs as necessary,
- close the flue gas deflector (17),
- regulate the fire intensity by regulating the volume of primary air via automatic regulator (12),
- **primary air MUST NEVER be supplied in any other manner when the automatic regulator (12) is used!**



WARNING! Never use flammable liquids, such as petrol and similar to ignite the fire and always keep these and similar liquids away from your cooker.



5.4.2. OPTIMUM USE VALUES

Primary air volume and chimney flue draught must be adjusted to levels that **prevent boiler water temperature from exceeding 85°C.**



Maximum quantity of fuel that can be accommodated in the firebox:

- 6 kg for C-20 2P cooker,
- 8 kg for C-30 2P cooker.



Adding fuel in regular intervals, in quantities of 2 to 4 kg, is recommended.



When using the oven for baking, it is recommended (to maintain constant temperature in the oven) to add 0,5 kg of fuel in regular intervals. It is also recommended to rotate the tray from 180° halfway through the baking process to ensure uniform baking!



Cooker optimum values may be achieved only if the cooker nominal power was chosen in accordance with the rules of profession and object energetic efficiency.

5.4.3. ADDING FUEL

Apart from use of appropriate fuel and satisfactory chimney flue draught, the manner in which the cooker is fuelled **also influences the glass cleanness.**



We recommend only **one layer in each fuel refill** and, if possible, the use of logs of length up to 2/3 of the firebox length. There should be a minimum distance of 1-2 cm between the logs.

Figure 17

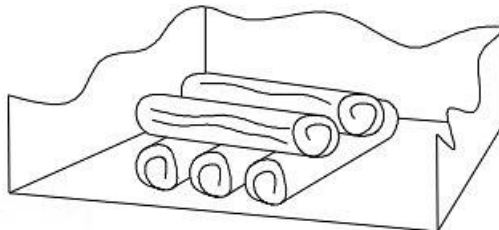

Briquettes should be used in amount that only covers the firebox surface, also with a **minimum distance of 1-2 cm** between them.

WARNING! New fuel quantities should be added only on top of embers, i.e., not on the flames, but only on top of embers (approx. 1 cm thick).



Primary air automatic regulator (12) must be completely closed at least 1 minute before opening the firebox door (8) to prevent the breach of flue gases into the residential area.



The door must be opened slowly. After adding the fuel, close the door slowly. **Open the primary air automatic regulator (12) to decrease the time of fuel combustion.**

Once the fuel starts burning, adjust the primary air automatic regulator (12) to a desired position ⇒ in accordance with *chapter 5.2*.

Flue gas deflector (17) MUST BE opened before opening the door!



5.4.4. FEEDING IN TRANSITION PERIOD

During the transition period, i.e. **when outdoor temperatures are higher**, sudden increase in outdoor temperature can **cause chimney malfunction** (decreased chimney flue draught) resulting with not all flue gases being expelled into the atmosphere.

It is therefore recommended to **use less fuel and smaller logs** during the transition period in order to achieve a more lively flame, as well as to **adjust the primary air volume** in order to improve the expulsion of flue gases from the chimney.



5.5. OVEN DOOR

Oven door are removed as shown in the following figure:

figure 18



- ◆ open the oven door all the way
- ◆ move the safety all the way back on the left and right oven hinges

- ◆ close the door halfway ensuring that the safeties lean against the door slits

- ◆ lift the ajar door (for around 15°) upwards for approx. 2 mm and lightly pull them towards yourself, inclining the door toward the cooker simultaneously
- ◆ pull the door from the cooker hinge bearing



Reverse the procedure to mount the door back!

WARNING! Always make sure that the hinge safeties properly fit in their bearings prior and after the removal of door!



Otherwise they might suddenly pop out during door removal or mounting, i.e. the hinge might suddenly close due to strong springs, which might cause injuries!



The oven door hinges must be periodically (at least once a year) lubricated with grease resistant to high temperatures (up to 400°C)!

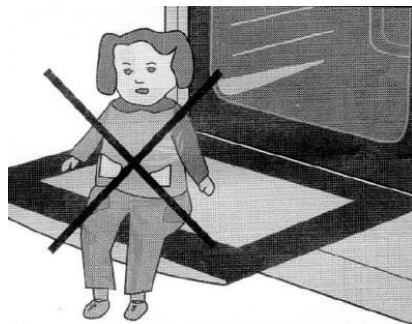
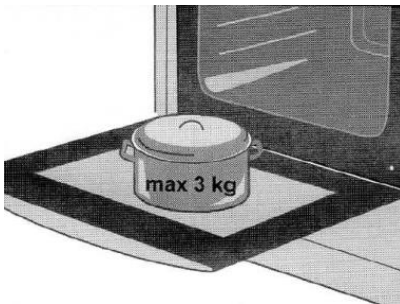

Oven door hinges can be damaged when overload, so on the open oven door do not stack hard cooking utensils (max 3 kg) and do not lean against the doors while cleaning the inside of the oven !

At the open door may not fit with your foot or sit on them (children) !



6. CLEANING

The cooker and the chimney must be regularly cleaned (at least once a month).

The ash box (14) and the box area must be cleaned on daily basis. Ash disposal is to be executed in environmentally acceptable manner and in accordance with safety procedures.

The glass (28) on the upper firebox door (8) should be cleaned as necessary using the soot and grease cleaning agent.



The oven (9) should be cleaned after every instance of use.

To clean the exterior surface, use a soft cloth with a neutral cleaning fluid. Never use metallic sponges and / or other similar sponge to avoid damaging the surface.



6.1. CLEANING THE FLUE GAS CHANNEL

While cleaning the top side of the cooker (*Figure 19*), it is necessary to remove the top plate (6) and cleaning hatch lids (10) which are located at the bottom of each oven, and thoroughly clean the soot from the boiler, around the ovens and flue gas deflector, including the chimney outlet opening (16).

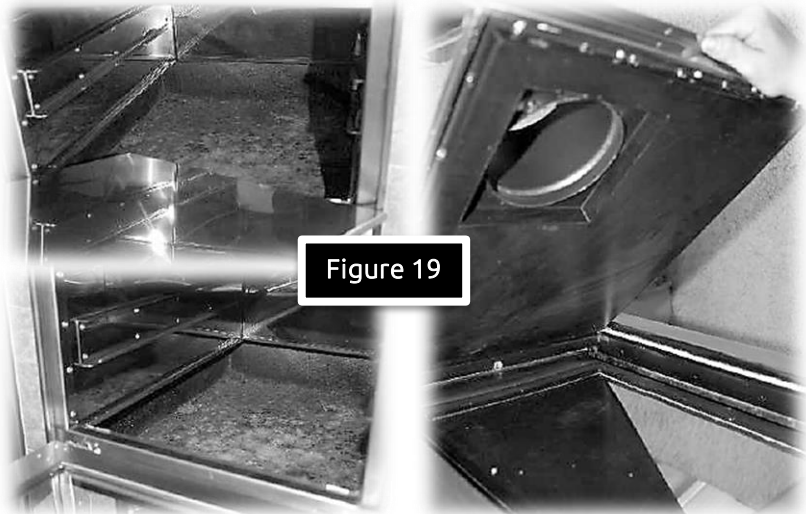

Cooker cleaning is to be performed only when the cooker is inactive and when it is cold!



7. MAINTENANCE



During the cooker use, the **chamotte insulation** (consumable material) suffers natural damage that must be repaired with chamotte putty. **It is not necessary to remove the chamotte insulation from the cooker.**



After a few hours of the first firing protective paint on the cooking plate will burn out causing an unpleasant smell. The smell disappears after a few hours of firing. The plate took on a greyish - operating color. This is **normal phenomenon and has no effect on plate lifespan.**



During the non-use of the cooker, it is IMPORTANT that **the cooking plate is smeared with a cloth dipped in edible oil** because due to moisture on the plate it may appear the layer of rust.

Stainless material on the cookers is susceptible to slight color change due to high temperatures. **Stainless materials are to be maintained exclusively with stainless material maintenance agents in accordance with the manufacturer's instructions.**



Handle **securing bolt** on upper and lower doors and **firebox door protective bolt** to be tightened if necessary.

7.1. AUTOMATIC REGULATOR

When replacing the automatic regulator, adhere to the following procedure:



- remove the automatic regulator PVC wheel (12) by pulling it towards yourself,
- remove the lid that is inside the fuel box (15) by releasing the 5 screws M8 (*Figure 20 a and b*),
- pull the automatic regulator lid all the way back (*Figure 20 c and d* ⇒ broken pointers),
- through the opening that is between ash box (14) and automatic regulator with wrench loosen the 4 screws M6 – *Figure 20 e i f*,
- after the automatic regulator has been released, it is necessary to pull the probe from the boiler,

- remove the protective lid which is located between the upper and lower doors and remove the probe from the boiler—*Figure 20g and h*,
- straighten the capillary that contains the probe and pull the capillary downwards through the opening above the automatic regulator on the inside of the cooker.
- **maximum allowed probe temperature is 90°C!**

The warranty is void if the probe temperature exceeds the maximum value!

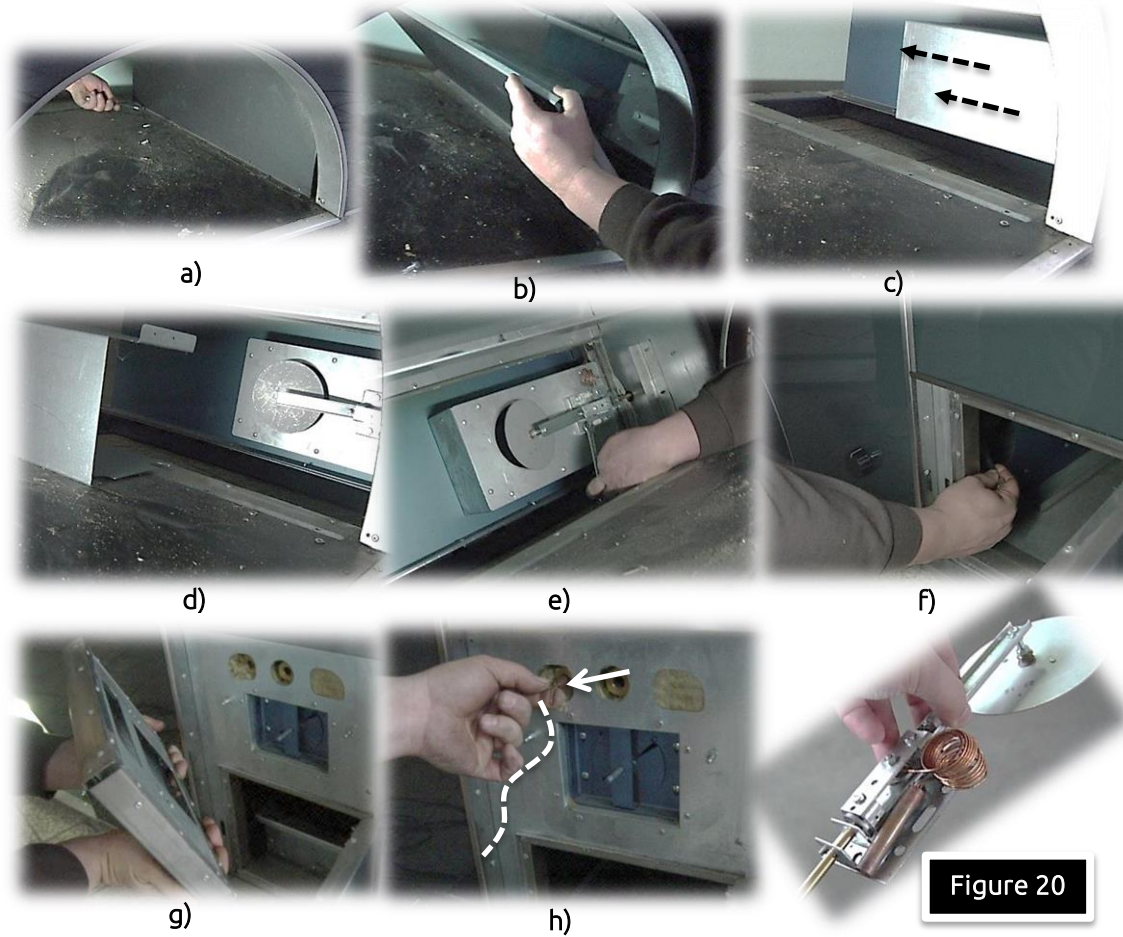

Figure 20

⇒ installation of a new regulator is executed by reversing the procedure, however, special attention must be placed on inserting the probe through the canal and into the boiler, probe capillary must not have an angle equalling or exceeding 90° at any point, and all transitions must be executed in slight radius!



7.2. FIRING REGIME SWITCH MECHANISM

Mechanism may become jammed during use due to solid ash debris, metal parts (i.e. nails), feeding with inappropriate fuels, exceeding the cooker nominal power. It is necessary to remove and clean the mechanism in those instances.

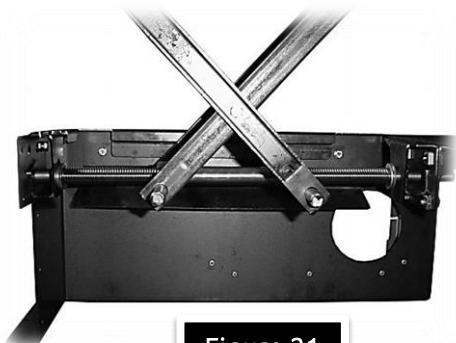

Figure 21

It is first necessary to check if only the grate is jammed. Remove the grate from the boiler and test the mechanism. If the mechanism cannot be launched at that point, it is necessary to remove and clean it.



Mechanism is removed by removing the protective sheet above the mechanism first and then by removing the 4 frontal screws, 4 rear-end screws and 2 screws on each, left and right sides, all using an OK10 wrench; and finally, by removing the entire mechanism (*Figure 21*). The mechanism is cleaned from impurities and reassembled by reversing the procedure.

7.3. OLD COOKER DISPOSAL



Once the cooker is no longer fit for use it must be delivered to an authorized disposal service specialized in recycling this type of waste. **It is forbidden to dispose of the old cookers in the natural environment!**

7.4. SPARE PARTS



Only original spare parts by the manufacturer are to be used. Should non-original spare parts be used or should the repair be executed by an unauthorized individual, the warranty will be void.

8. MALFUNCTIONS / CAUSES / SOLUTIONS



PROBLEM	POSSIBLE CAUSE	SOLUTION
Firebox door glass is black and/or the firebox is smoky (black soot)	<ul style="list-style-type: none"> ◆ insufficient flue draught (less than 10Pa) ◆ faulty regulation ◆ too much fuel in the firebox ◆ fuel too moist ◆ inadequate fuel ◆ excessive firebox temperature 	<ul style="list-style-type: none"> ⇒ check the connection of the cooker with the chimney and the chimney ⇒ study <i>chapters 4.2. and 4.3.</i> ⇒ study <i>chapter 5.2.</i> ⇒ reduce the fuel quantity ⇒ use fuel with less than 17% of relative moisture ⇒ use fuel as described in <i>chapter 1.1.</i> ⇒ reduce the fuel quantity and primary air volume and adjust chimney flue draught in accordance with <i>chapter 5.2.</i>
There is noise from the boiler	<ul style="list-style-type: none"> ◆ insufficient water level in the central heating system ◆ insufficient water pressure in the central heating system ◆ improper central heating installation ◆ during the summer period, the boiler is not connected to the water heating boiler ◆ the cooker is not placed in a horizontal position with the use of spirit level ◆ excessive velocity of water flow in the system ◆ air in the system 	<ul style="list-style-type: none"> ⇒ refill the central heating system with the necessary amount of water to achieve 2 bar pressure ⇒ increase water pressure to 2 bar ⇒ execute the central heating installation in accordance with professional standards and DIN 4751 norm - part 1 for open systems, i.e. 4751 – part 2 for closed systems ⇒ connect the boiler to water heater ⇒ mount the cooker as described in chapter 4.1. ⇒ reduce the water circulation velocity by adjusting the number of pump rotations ⇒ properly and thoroughly vent the system
Insufficient flue draught in the chimney; black smoke expelled from the chimney	<ul style="list-style-type: none"> ◆ chimney filled with soot ◆ cooker filled with soot ◆ chimney partially clogged or filled with soot ◆ fuel not sufficiently dry ◆ firebox cast grate turned in the wrong direction ◆ upper or lower door opened ◆ inadequate flue draught ◆ faulty regulation 	<ul style="list-style-type: none"> ⇒ clean the chimney ⇒ clean the cooker ⇒ unlog and clean the chimney ⇒ use fuel in accordance with <i>chapter 1.1.</i> ⇒ set the grate in accordance with <i>chapter 5.3.</i> ⇒ close the door ⇒ adjust the flue draught in accordance with <i>chapter 4.2.</i> ⇒ adjust the primary and secondary air

		in accordance with <i>chapter 5.2.</i>
Smoke coming out of the cooker	<ul style="list-style-type: none"> ◆ cooker filled with soot ◆ chimney filled with soot ◆ fuel too moist ◆ low calorie fuel ◆ levels of fresh air in the room too low ◆ return water temperature too low ◆ firebox temperature too low ◆ chimney lower than 4.5 m ◆ chimney diameter smaller than the one prescribed 	<ul style="list-style-type: none"> ⇒ clean the cooker as described in <i>chapter 6.</i> ⇒ clean the chimney as described in <i>chapter 6.</i> ⇒ use fuel as described in <i>chapter 1.1.</i> ⇒ study <i>chapter 4.4.</i> ⇒ set the thermostat to activate the pump at temperatures over 55°C ⇒ increase the firebox temperature by increasing fuel quantity ⇒ adjust the chimney in accordance with <i>chapters 4.2. and 4.3.</i>
Water leaking from the boiler (boiler condensation)	<ul style="list-style-type: none"> ◆ excessive water flow ◆ fuel too moist ◆ boiler damaged ◆ insufficient fuel quantity ◆ insufficient primary air volume 	<ul style="list-style-type: none"> ⇒ reduce the water flow ⇒ use fuel as described in <i>chapter 1.1.</i> ⇒ call an authorized maintenance technician ⇒ add more fuel to the firebox ⇒ increase primary air volume in accordance with <i>chapter 5.2.</i>, check the functionality of the primary air automatic regulator
Cooking and baking temperature too low	<ul style="list-style-type: none"> ◆ insufficient or excessive chimney flue draught ◆ excessive primary air volume ◆ inadequate fuel ◆ too much fuel – combustion difficult ◆ flue gas deflector opened ◆ grate too low during summer period 	<ul style="list-style-type: none"> ⇒ adjust the chimney flue draught in accordance with <i>chapter 4.2.</i> ⇒ reduce primary air volume ⇒ use fuel as described in <i>chapter 1.1.</i> ⇒ add less fuel to the firebox ⇒ close the flue gas deflector ⇒ set the grate height as desired
Cooking and baking temperature too high	<ul style="list-style-type: none"> ◆ excessive chimney flue draught ◆ inadequate fuel ◆ flue gas deflector closed ◆ grate too high during summer period 	<ul style="list-style-type: none"> ⇒ reduce the chimney flue draught in accordance with <i>chapter 4.2.</i> ⇒ use fuel as described in <i>chapter 1.1.</i> ⇒ open the flue gas deflector ⇒ lower the grate
Outlet boiler water does not reach the required temperature	<ul style="list-style-type: none"> ◆ central heating system improperly dimensioned ◆ insufficient fuel quantity ◆ central heating system thermometer does not display the temperature properly 	<ul style="list-style-type: none"> ⇒ dimension the central heating system according to professional standards and DIN 4751 norm – part 1 for open systems, i.e. DIN 4751 – part 2 for closed systems ⇒ adjust the water flow in accordance with the boiler thermal possibilities ⇒ add more fuel to the firebox in accordance with <i>chapter 5.4.2.</i> ⇒ install functional and approved (moderate) thermometer
Raising or lowering the	<ul style="list-style-type: none"> ◆ non-combustible material debris between the grate and 	<ul style="list-style-type: none"> ⇒ thoroughly clean the non-combustible material debris

grate somewhat difficult

the boiler (nails and similar)

◆ malformed boiler

⇒ call an authorized maintenance technician

9. TECHNICAL SUPPORT

Dear client,

If you were unable to find the solution to the malfunctions, that potentially developed while using your product, in the table above, please feel free to contact our complaint and support service:

- Tel.: +385 (0)40 337 344
- Fax.: +385 (0)40 337 906
- E-Mail: info@senko.hr, podrska@senko.hr

WE'D LIKE TO TAKE THIS OPPORTUNITY TO REMIND YOU WHAT YOU NEED TO POSSES WHEN CONTACTING OUR COMPLAINT AND SUPPORT SERVICE:

Before you contact us, prepare the following documents:

- **purchase receipt with the date of purchase**,
- **warranty** (at the back of this *Manual*),
- **written installation report** (at the back of this *Manual*),
- **Instruction manual**.



The documents listed above are necessary to ensure the quickest and clearest removal of the occurring malfunction!

10. TECHNICAL DATA

SENKO cooker		C-20 2P	C-30 2P
Nominal heat output, kW		25	35
Boiler, kW		16	20
Room, kW		9	15
Amount of water in boiler, L		20	28
Operating pressure (max), bar		3	
Operating temperature, °C		85	
Width, mm		1400	
Depth, mm		680	815
Height, mm		850/1255	
Weight, kg		450	520
Firebox opening (W × H), mm		200×260	
Firebox (W × D), mm		275×430	275×570
Firebox volume, dm ³		62,08	82,29
Fuel consumption, kg/h		9	10
Height of grate lifting, mm		170	
Cooking plate (W × D), mm		595×465	595×595
Cooking plate area, m ²		0,276	0,354
Oven (width), mm		330	
Oven (height), mm		220	
Oven (depth), mm		440	550
Ash pan, L		7,5	10,5
Fuel box, L		31,6	
Flue gases exhaust, mm		Ø 150	
Flue gas temperature, °C		250	270
Required flue draught, Pa		12	16
CO in flue gases at 13% O ₂ , %		0,5	0,56
Flue gas mass flow rate, g/s		17	33,6
Efficiency, %		75	75,5
Regulation	Primary air	automatic	
	Secondary air		
Manufactured in accordance with EN norm		EN 12815	

- technical specification apply to wood logs and wooden briquettes used as fuel
- technical specifications are indicative and may vary as such. The manufacturer withholds the right to change any technical specification to further improve the products

11. TERMS OF WARRANTY

These warranty conditions are valid in all European countries, in which SENKO products are sold. The client addresses the manufacturer/dealer or the nearest authorized servicing agent for all complaints; providing the purchase receipt with the date of purchase, warranty and installation report in the process.

DURATION OF THE WARRANTY

Manufacturer SENKO d.o.o. provides a **2-year** warranty for its product, starting from the date of embedded boiler purchase. All other parts (thermometer, automatic regulator with the probe, regulation buttons, oven door hinges) have a **6-months** warranty.

The manufacturer guarantees that the product was manufactured and certified according to the EN 12815 norm and that it complies with all the demands set by the norm. The user is obligated to adhere to the Instruction manual.

EXCEPTIONS

Exceptions are parts subject to wear such as chamotte and chamotte plates, cast grate, ash box, seals and glass panes.

Chamotte plates (changes in colour or cracks are dependent on the material and can never be completely ruled out). However, they do not impair the functioning of the appliance (as long as the plates remain in the firebox) and they are not a motive for complaint.

Glass panes (breakage of glass because of external hazard, changes on the surface due to thermal influences such as fly-ash or soot at the surface of the glass).

Discolouring of paint due to overload of thermal strain.

Seals (e.g. hardening or breakage due to thermal or mechanical strain).

Surface coatings (frequent cleaning or cleaning with abrasive cleaning agents).

Castings and parts which are subject to high thermal stress such as firebox grate, cooking plate or ash box.

Heat exchanger (boiler) is not subject to the warranty in the event in which it is not secured with adequate anti-condensate circuit which guarantees a minimum return water temperature of at least 55°C.

REPAIRS

Possible repairs within the warranty will be executed within 30 days from the date of product delivery to the manufacturer. Should the repairs not be executed within 30 days from the delivery to the manufacturer, the product will be replaced with a new one. The manufacturer will notify the client about the executed repairs. The client is obligated to take over the product within 5 days from the repair completion.

COSTS

The manufacturer does not defray any delivery and return costs.

Prior to commencement of repairs within the warranty (for damages caused by incorrect use, cooker transport and mounting), the manufacturer will notify the client about the repair price in written form. Once the client agrees, the manufacturer will execute the repairs and charge the client for the repairs.

SPARE PARTS

Original parts replaced within the warranty do not have to match the removed parts in external physical appearance, but they must match them in quality and functionality.

DISCLAIMER OF LIABILITY

Manufacturer cannot accept any liability for the loss or the damage of an appliance through theft, fire, vandalism or similar causes. Indirect or direct damage caused to the product, which is the result of improper transportation of the product, are excluded from the liability. We cannot accept any liability for damages caused by chemical or electrochemical effects (e.g. pollutants in the combustion air, water scale and similar) which are the result of improper installation of the product and violation of this instruction manual.

ADDITIONAL TERMS

Small dimensional differences in construction materials and parts of the cooker are not a reason for complaint. During the period in which the product was inefficient, we will not grant any compensation. This warranty applies only to the customer specified in the warranty sheet and cannot be transferred to others.

The warranty is void if the user made alterations to the product without manufacturer's prior knowledge. If the user was negligent and performed maintenance on the wrong way. If the user is using fuel that is not compliant with the types and quantities indicated in this Manual

The warranty is valid if the installation was executed by an authorized professional and upon presenting the written installation report.

Possible disputes to be settled by the competent Court in Čakovec.

WARRANTY No.

SOLID FUEL CENTRAL HEATING COOKER:

- C-20 2P/E2125L C-20 2P/E2125D C-20 2P/E2220L C-20 2P/E2220D
 C-30 2P/E2135L C-30 2P/E2135D C-30 2P/E2230L C-30 2P/E2230D
 C-20 2P/E2420L C-20 2P/E2420D C-30 2P/E2430L C-30 2P/E2430D

SERIAL NUMBER: _____

DATE OF MANUFACTURE: _____

STORE NAME AND ADDRESS: _____

CLIENT NAME AND ADDRESS: _____

DATE OF PURCHASE: _____

STORE STAMP AND DEALER SIGNATURE: _____

Complaints within warranty – product information:

Faulty product date of receipt: _____
Malfunction description (client): _____ _____
Servicing agency comments: _____ _____
Servicing completed on date: _____
Stamp and servicing technician signature : _____

Faulty product date of receipt: _____
Malfunction description (client): _____ _____
Servicing agency comments: _____ _____
Servicing completed on date: _____
Stamp and servicing technician signature : _____

COMPLETED BY THE CHIMNEY-SWEEPER

Chimney connection executed by the company:

Company/Business: _____ Person in charge: _____
stamp and signature

Street: _____ City: _____

Telephone: _____ Country: _____

Date: _____ Client signature: _____

Chimney

Type:

Dimensions (mm):

Height (m):

Draught (Pa):

Flue gases exit temperature (°C):

Last inspection date:

Number of connections:

Smoke venting pipe (if connected)

Cross-section (mm):

Length (m):

Number of elbows:

Air supply pipe (if connected)

Cross-section (mm):

Length (m):

Number of elbows:

COMPLETED BY THE CENTRAL HEATING INSTALLATION CONTRACTOR

Central heating system connection executed by the company:

Company/Business: _____ Person in charge: _____
stamp and signature

Street: _____ City: _____

Telephone: _____ Country: _____

Date: _____ Client signature: _____

Open system yes no

Closed system yes no

Connection execute in accordance with DIN 4751 yes no

Heated space volume (m³):

Expansion tank volume (m³):

Pump type:

Water flow (m³/h):

Safety valve type: Safety valve approved atbar

Water temperature (°C) ⇒ inlet: ⇒ outlet:



Senko d.o.o.
 Vladimira Nazora 22, Štefanec
 40 000 Čakovec, Republic of Croatia
 12

EN 12815:2001 / A1:2004 / AC:2007

Solid fuel central heating cookers with oven

	C-20 2P	C-30 2P
Minimum distance from flammable surfaces:	above 100 cm front 80 cm rear 20 cm sidebar 20 cm	
CO emission in flue gases (at 13% O₂):	0,5 %	0,56 %
Maximum operational water pressure:	3 bar	
Flue gases temperature:	250 °C	270 °C
Heat output – water:	16 kW	20 kW
Heat output – space:	9 kW	15 kW
Efficiency:	75 %	75,5 %
Fuel type:	wood logs, wood briquettes	
Fuel consumption:	9 kg/h	10 kg/h
Certificate No:	E-30-00435-12	

Read and follow the Instruction manual. Use only recommended fuel.
Manufactured in the Republic of Croatia

DECLARATION OF CONFORMITY

This product is certified in accordance with the EN 12815. Test report number 30-11665/4 from June 29th, 2012.

NOTES:

*For a perfect
warm home!*



SENKO

Vladimira Nazora 22, Štefanec, 40000 Čakovec, Hrvatska
Tel: +385 (0)40 33 73 44 • E-mail: info@senko.hr

www.senko.hr



*... THE SPIRIT OF TRADITION
IN MODERN FORMS FOR
A HEALTHY ENVIRONMENT.*

facebook

You Tube



You can find this Manual at <http://en.senko.hr/>